

Article number: 203180M1247B2X

Description: E+G levelling foot

GN 31-80-M12-47-B2-X

Note: X With female thread, External hexagon

Measures

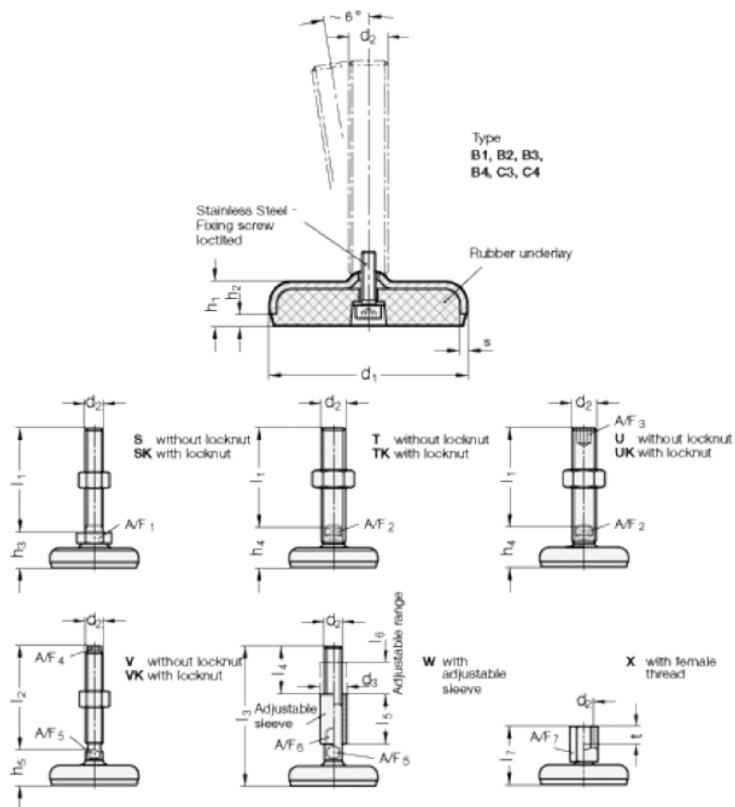

A/F7	= 17
d1	= 80
d2	= 12
h1	= 18
h2	= 5
l7 +4.0/0	= 47
s	= 3
t	= 12